

EMPLAÇAMENT I SITUACIÓ

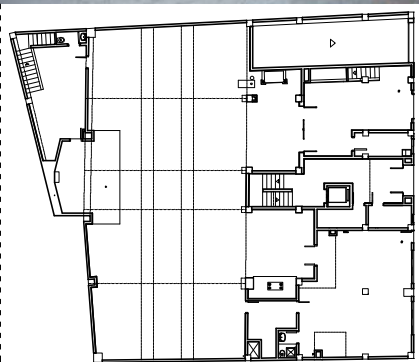

PLANTA BAIXA ESTAT ANTERIOR, E: 1/500

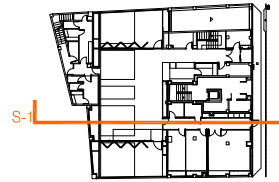

PLANTA BAIXA, E: 1/200

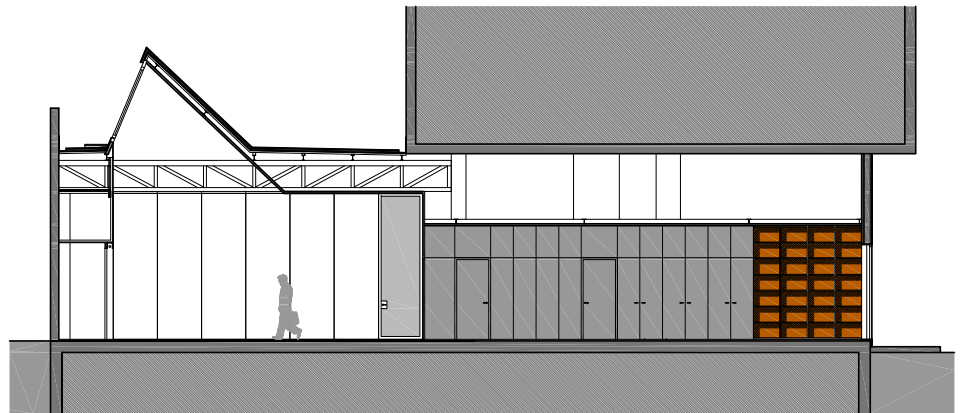

S-1, SECCIÓ LONGITUDINAL, E: 1/200



A-1, ALÇAT PRINCIPAL, E: 1/200

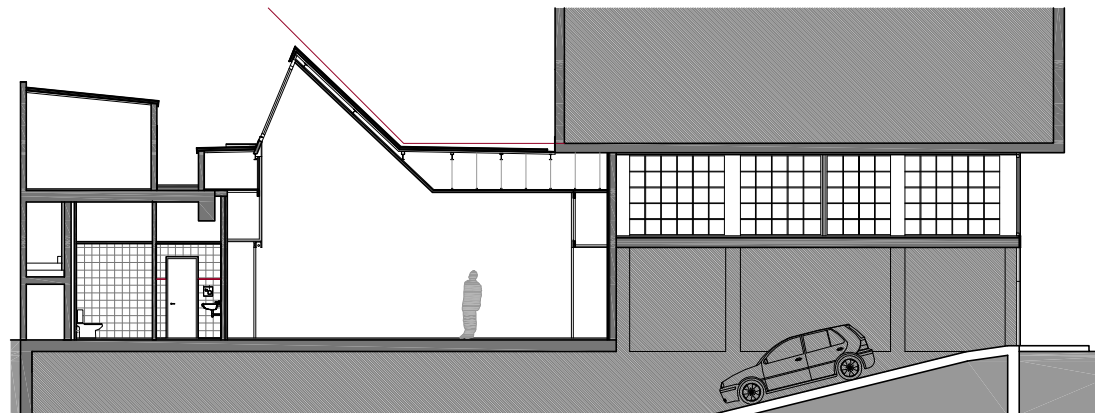

S-2, SECCIO LONGITUDINAL, E: 1/200

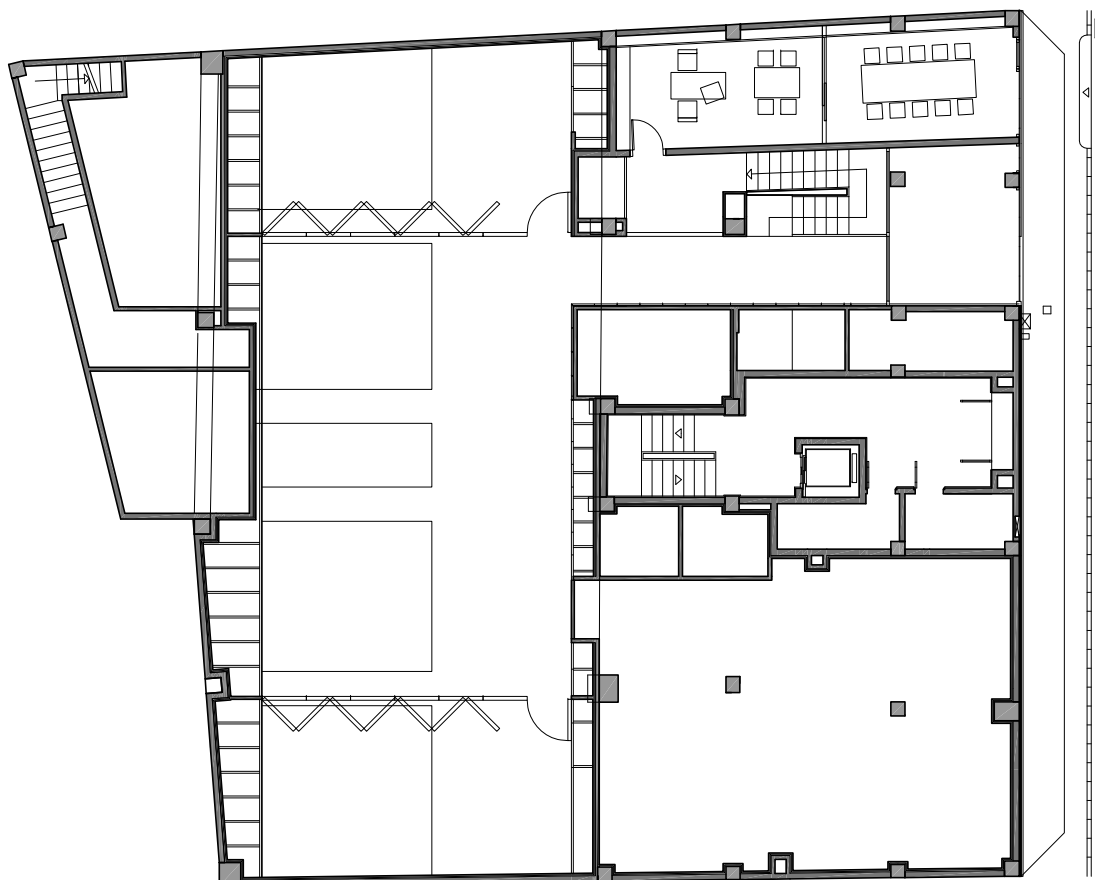
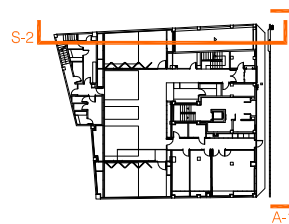

PLANTA ALTELL, E: 1/200

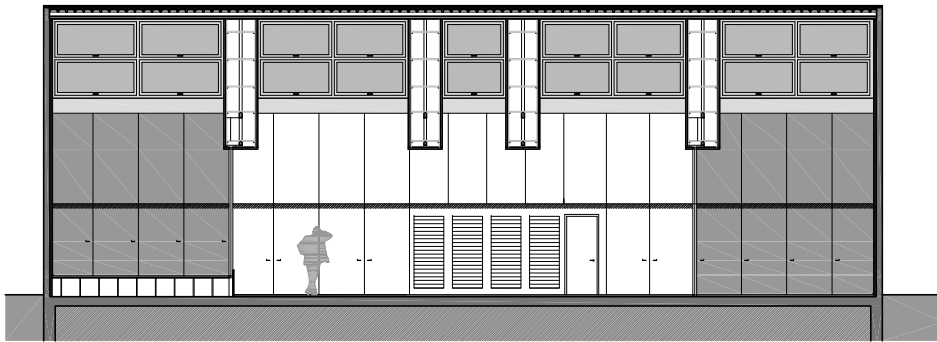

S-4, SECCIO TRANSVERSAL, E: 1/200 

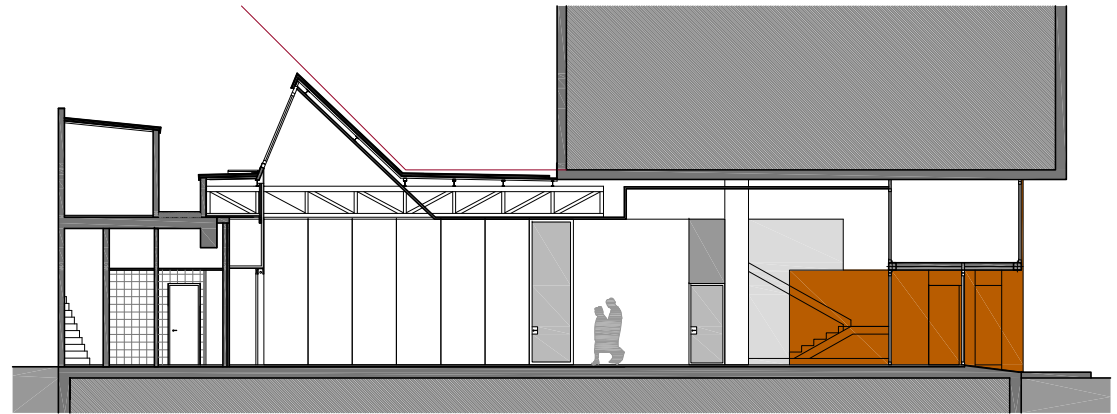

S-3, SECCIO LONGITUDINAL, E: 1/200 

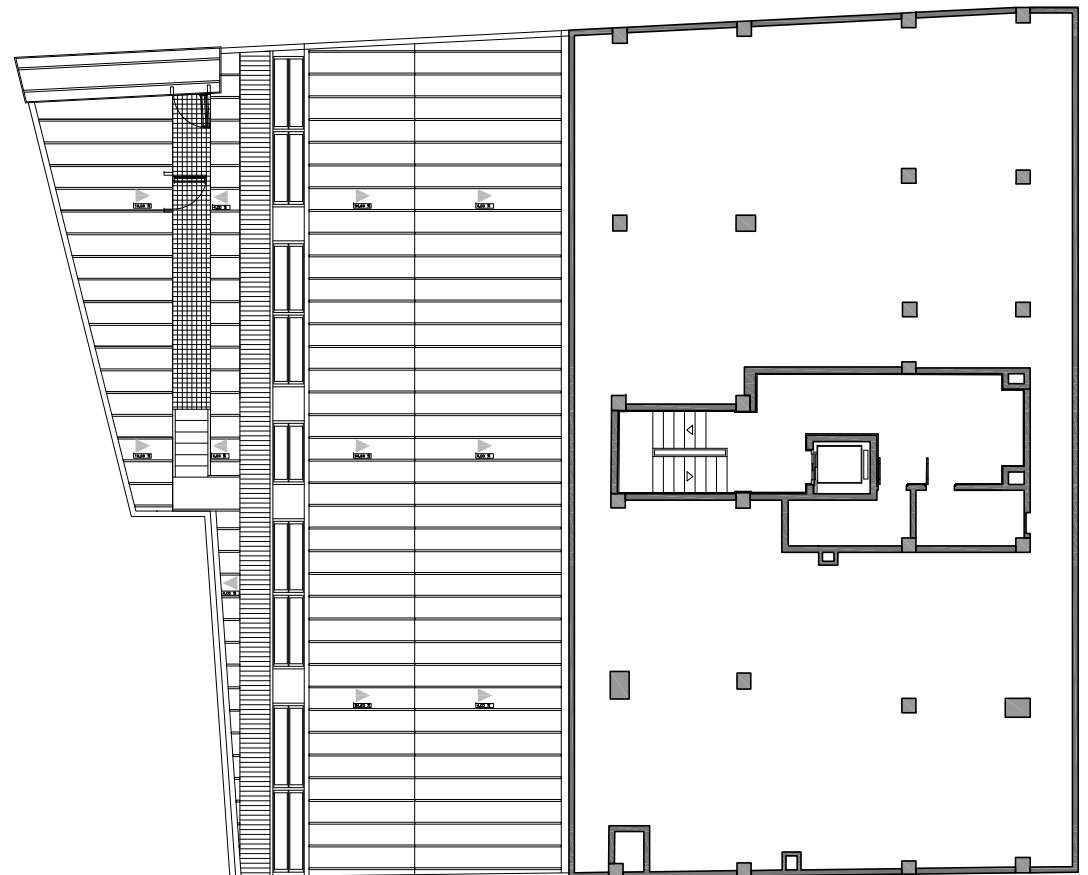

PLANTA BAIXA, E: 1/200 

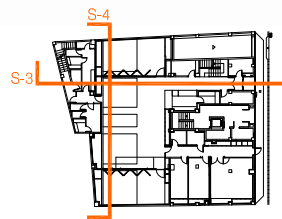

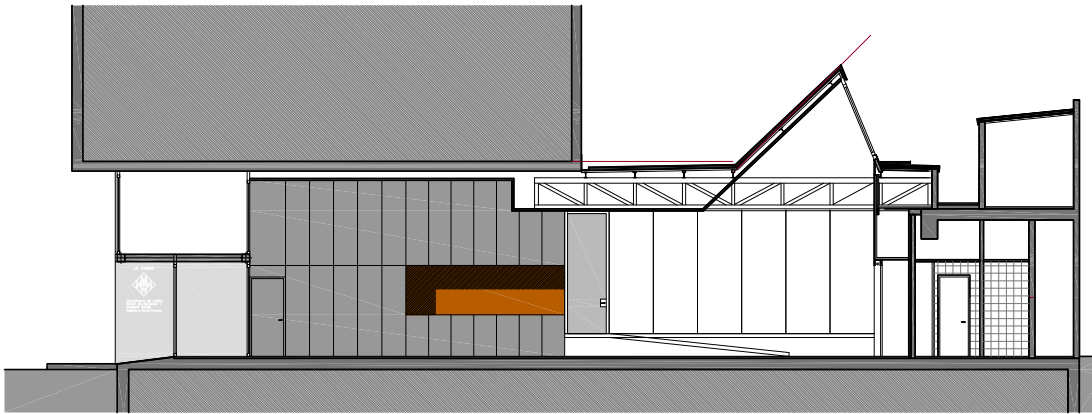

S-5, SECCIO LONGITUDINAL, E: 1/200

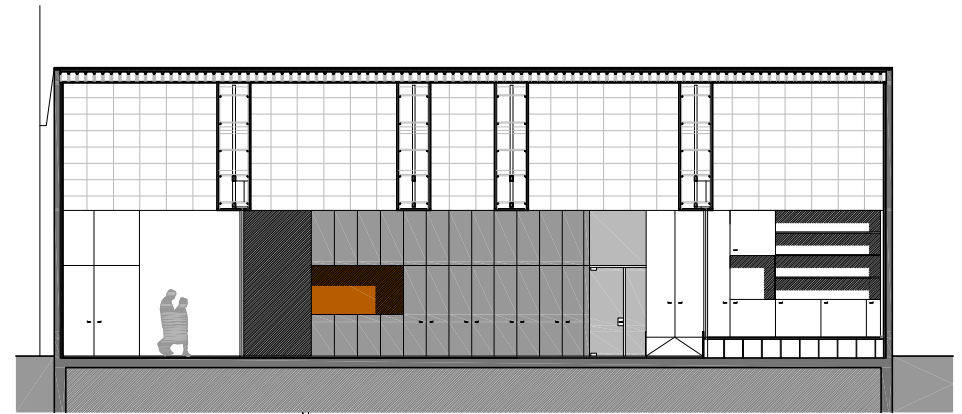

S-8, SECCIO TRANSVERSAL, E: 1/200

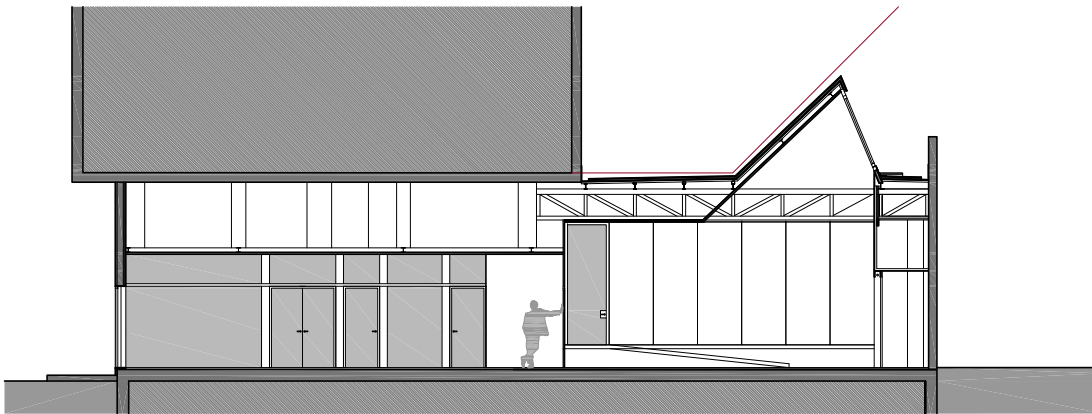

S-6, SECCIO LONGITUDINAL, E: 1/200

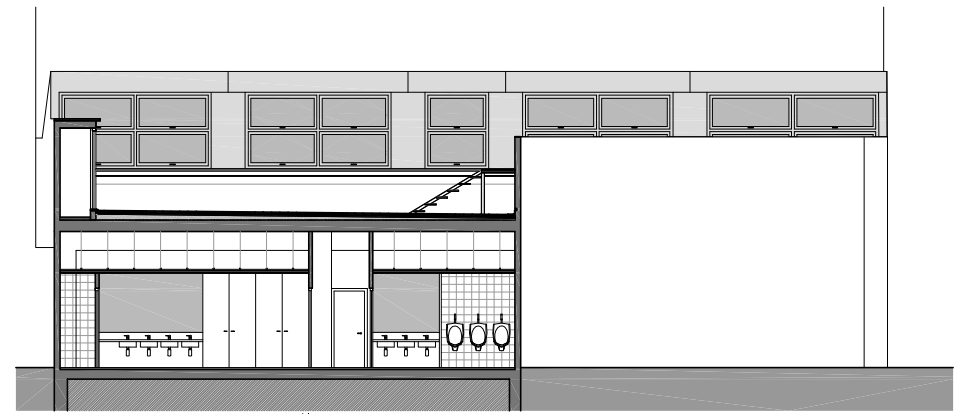

S-9, SECCIO TRANSVERSAL, E: 1/200

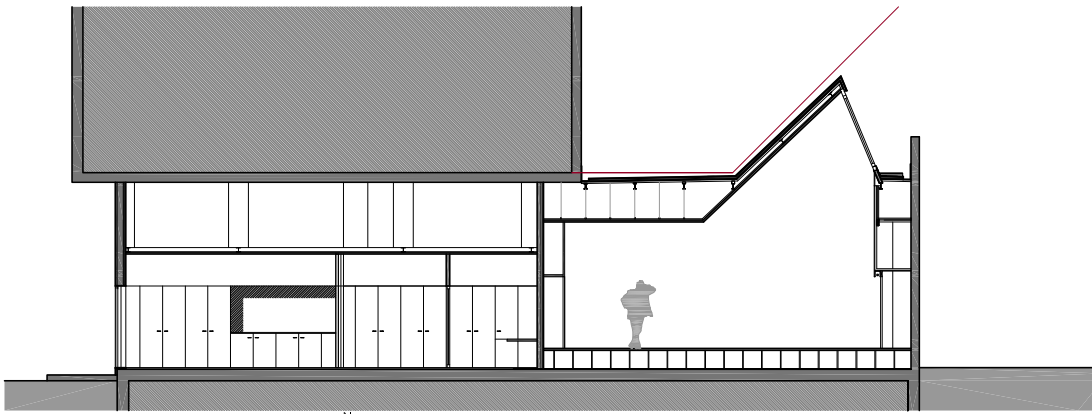

S-7, SECCIO LONGITUDINAL, E: 1/200



S-10, SECCIO TRANSVERSAL, E: 1/200

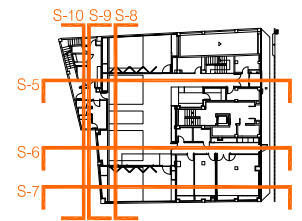

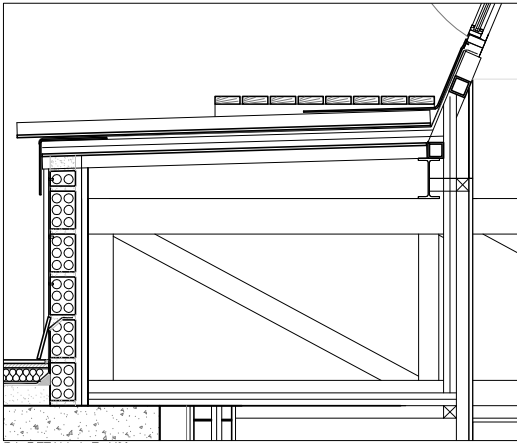

D1, DETALL 1, E: 1/30

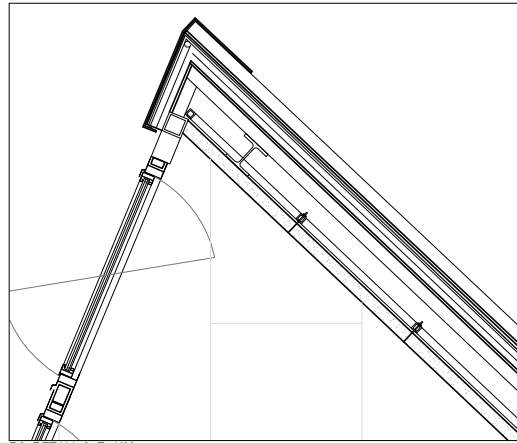

D2, DETALL 2, E: 1/30

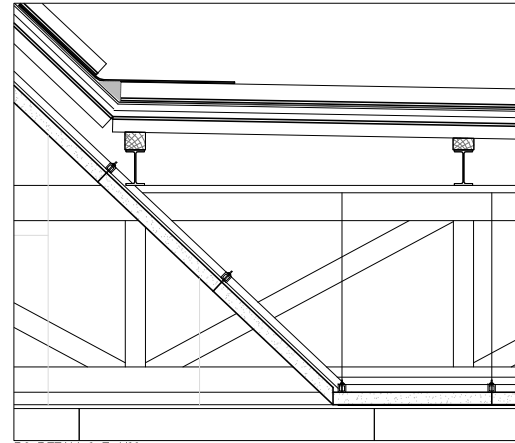

D3, DETALL 3, E: 1/30

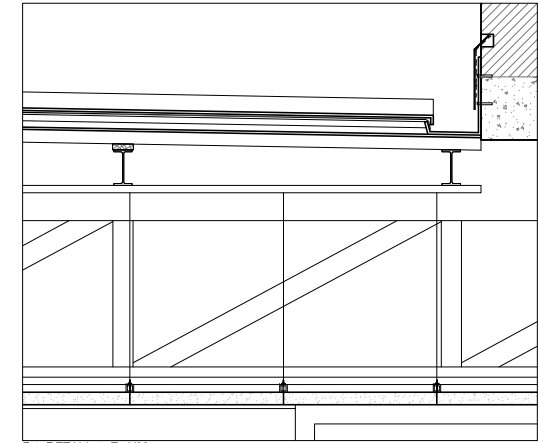

D4, DETALL 4, E: 1/30

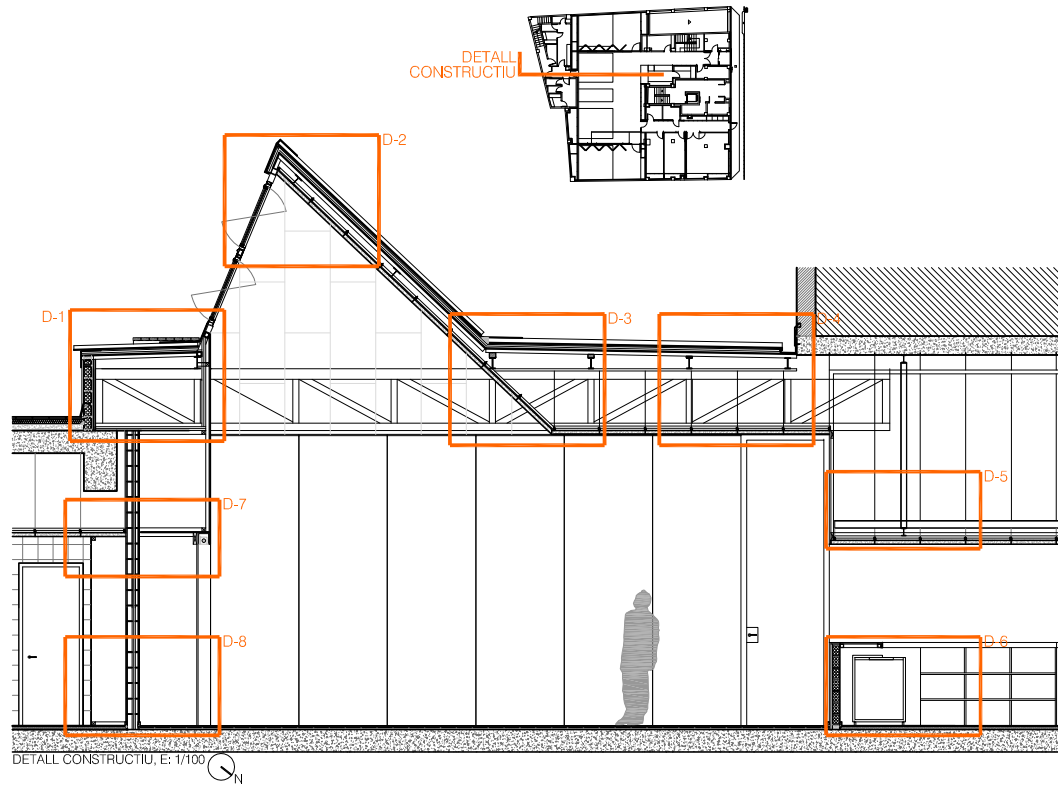

DETALL CONSTRUCTIU, E: 1/100

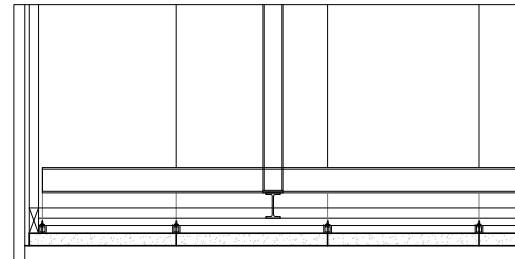

D5, DETALL 5, E: 1/30

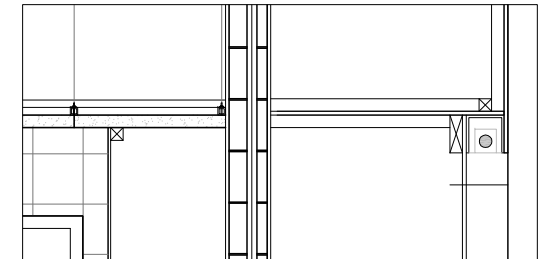

D7, DETALL 7, E: 1/30

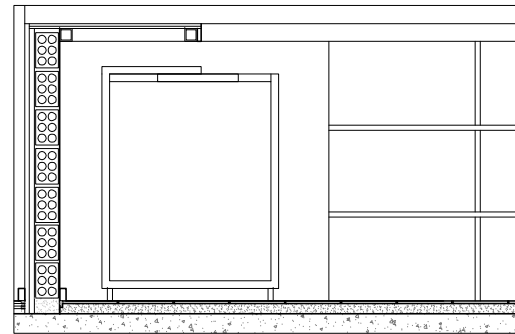

D6, DETALL 6, E: 1/30

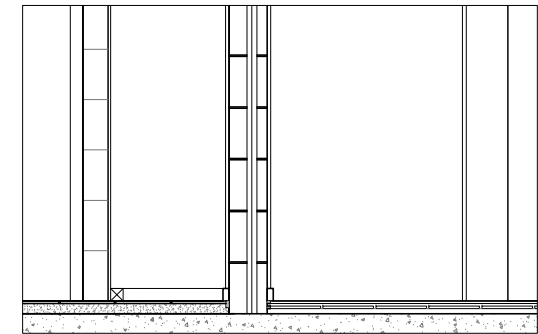

D8, DETALL 8, E: 1/30